



**vegetali.D.**<sup>®</sup>  
innovation & Development

# INSTALLATION AND MAINTENANCE GUIDE

FOR

**HYDROPACK GREEN ROOF TRAY**

---





HYDROPACK®'s installation

## HYDROPACK TECHNOLOGY



ALL IN ONE TRAY !

## HYDROPACK® INSTALLATION GUIDE

This section is an easy-to-follow instruction guide to install HYDROPACK®. Please read it carefully before you schedule and organize the installation and fax the certification (at the end of this document) back to Vegetal i.D. 585-343-6401

### Disclaimer:

The contractor is responsible for the quality and viability of every HYDROPACK® installation. Care should be taken to avoid damaging the waterproofing membrane and the plants, both before and during the installation.



HYDROPACK® size: 24" x 16" (60 cm x 40 cm)

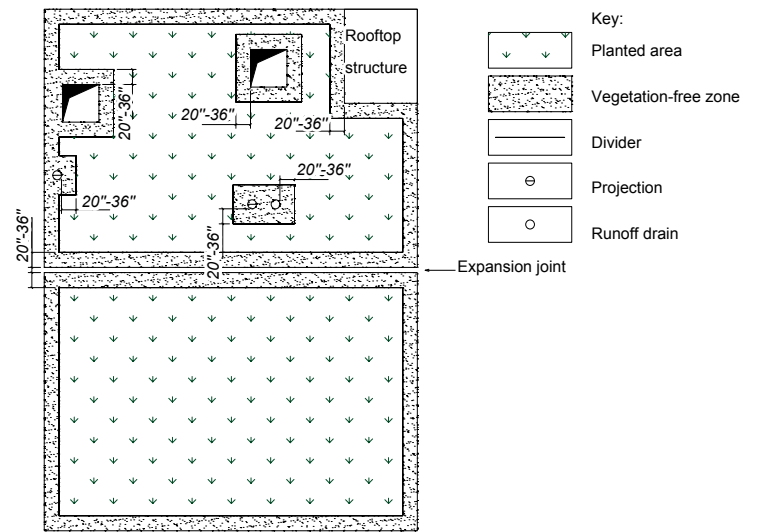

Layout of Vegetation-Free Zone

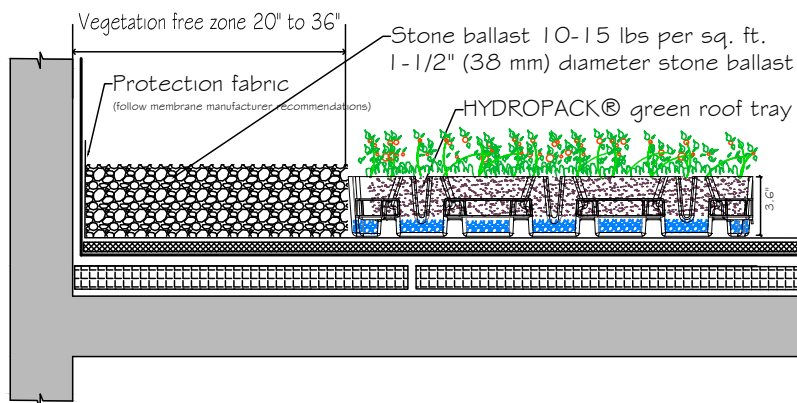

Vegetation-Free Zone profile

## ACTIONS

✔ **Vegetal i.D.** will contact you to set up the shipment. If you need to postpone the shipment, contact our logistic specialist at least 10 days before the shipment. When delaying for more than 2 months, we might charge you for the maintenance of the plants.

✔ Read and follow carefully the architect's specifications and the waterproofing membrane manufacturer's requirements. Find out which protection fabric, root barrier and vegetation free zone are often required by membrane manufacturers to obtain the TSW (removal warranty) from them.

✔ Before installing the modules, inspect the waterproofing surface to ensure that it is watertight. This will require a flood test (the controlled flooding of the entire roof with no less than 2 inches of standing water).

✔ The surface of the waterproofing membrane should be swept and washed.

✔ While the protective fabric is being put into place, no other activity should be carried out on the roof.



The **Vegetal i.D.** team can provide you with support for your green roof design, including CAD drawings, selection of plants, installation, and maintenance. Don't hesitate to give us a call if you have any questions. Tel: 585-343-6400.

Is this your first **HYDROPACK®** installation? Call us to ask a representative to come onsite.

## INFORMATION WE NEED

- ✔ Desired date and time of delivery
- ✔ Contact onsite: name, phone, email
- ✔ Type of truck (dry van, flat bed, etc.)



*HYDROPACK® pallets*



*Inspection of the membrane and the protection fabric*

The **HYDROPACK®** trays are stacked on top of each other on a standard pallet. Per truckload, we can transport about **3,200 sq. ft.** 1,200-1,280 trays (288-308 m<sup>2</sup>)

One pallet is 2,200 lbs; **156-166 sq. ft.**, 60-64 trays (14.4- 15.4 m<sup>2</sup>)

We use flat beds, dry vans and temperature controlled reefer trucks – simply tell us which is most convenient for you.

## TOOLS NEEDED

- ✔ Pallet Jack
- ✔ Forklift/Bobcat with forks, or a crane (if shipped on a flat bed)
- ✔ Lifting device for lifting the pallets onto the roof

## ACTIONS

- ✔ Unload the pallets and place them in the shade to protect the vegetation from direct sunlight.
- ✔ Be ready to install **HYDROPACK®** on the day of delivery.
- ✔ Each pallet weighs about 2,200 lbs.
- ✔ Lift the **HYDROPACK®** pallet to the roof without putting it down. If you're using a crane, protect the roof before lowering the pallet, and make sure that the roof is strong enough to take the weight.
- ✔ Lift the pallets as close as possible to the place where they are going to be installed.

Unloading

1 full truck



40 min



2 persons



You can postpone the shipment, but no later than 10 days before the merchandise leaves the nursery.

If the trays cannot be installed the same day, contact **VEGETAL I.D.** for instructions.



*HYDROPACK® pallet lifted by crane*



*Lifting the HYDROPACK® pallet onto the roof*



*HYDROPACK® pallet on the roof*

## TOOLS NEEDED

- 🌱 Gloves for each crew member
- 🌱 3 Knives or 3 pairs of scissors
- 🌱 1 Wheelbarrow (if gravels in the vegetation free zone)
- 🌱 1 Chalk Line
- 🌱 1 Circular saw or reciprocating saw
- 🌱 1 Shovel

## ACTIONS

- 🌱 Roll out the Root Barrier and/or protection fabric over the waterproofing membrane (consult the waterproofing manufacturer's recommendations)
- 🌱 Overlap the sheets by a minimum of 2 inches.
- 🌱 Take 2 empty **HYDROPACK®** trays and place them at one corner of the roof. This will allow you to visualize the sequence you will follow when arranging the rest of the trays. The order should always be from left to right.
- 🌱 Remember: for most specifications you will need to create a Vegetation-free Zone along the perimeter of the roof and around any rooftop equipment. Measure the width of the vegetation-free zone and draw a straight line with the chalk line to mark out the edges from which you will start installing the trays. The lines have to form a perfect 90 degree angle.
- 🌱 In some cases you may find it necessary to cut **HYDROPACK®**. If so, empty the tray using the filter fabric to lift the soil. Cut the tray with a circular saw/knife or reciprocating saw. Position the tray with the remaining edges facing outward. Cut the soil and plants with a knife and replace them in the tray.
- 🌱 When all the trays are installed, fill the space around the perimeter with gravel ballast. Use the wheelbarrow to move the gravel around the roof, and use the shovel to spread it.

We can tell you at which corner of the roof it will be easier to start from! Call us now 585-343-6400

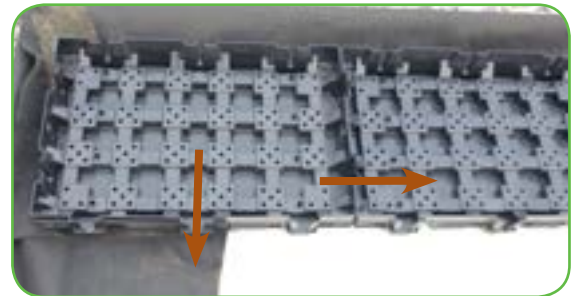

Visualization of the positioning



*HYDROPACK®* installation

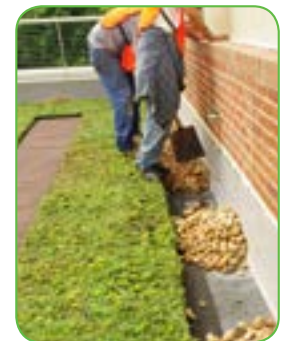
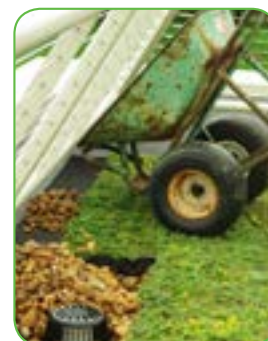

Vegetation-free zone

## TOOLS NEEDED

- 👉 Gloves

## ACTIONS

- 👉 Hold the **HYDROPACK®** tray with the female hooks facing you.
- 👉 Position the tray next to the trays already in place.
- 👉 Holding the tray by the top right hand and bottom left hand corners; lift them ½”.
- 👉 Slide the male hooks down into the female hooks.
- 👉 If the hooks don't slide in all the way use your foot to press them into place.

### FEMALE HOOK

### MALE HOOK

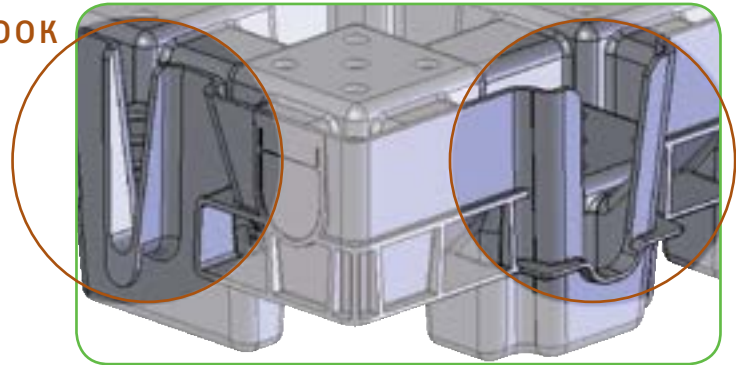

Male hook on the left; Female hook on the right

We recommend that 2 crew members hook the trays and the others pass them along.



2 crew members hook, 2 crew members bring the trays

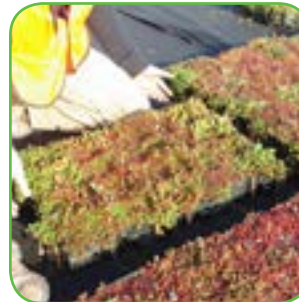

Hooking **HYDROPACK®** trays

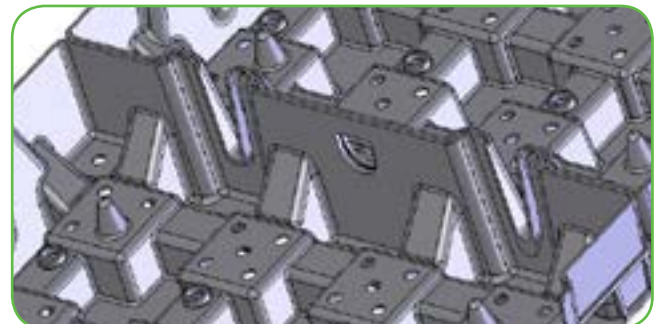

**HYDROPACK®**'s hooking system is a pathway for water



## TOOLS NEEDED

- 1 Circular saw or reciprocating saw

## ACTIONS

If you find it necessary to cut **HYDROPACK®**, empty the tray using the filter fabric to lift the soil. Cut the plastic tray with a circular saw/knife or reciprocating saw. Position the tray with the remaining edges facing outward. Cut the soil, filter and plants with a knife and place them back into the tray.



*Cutting the plastic tray*

We recommend emptying the tray before cutting the plastic



*Emptying the tray*

1 2



*Placing the tray with edges facing outward*



*Placing the mineral drainage back into the reservoirs*

3 4



*Cutting the vegetation and soil with a knife, keep the filter*

**HYDROPACK®** can be cut easily to fit odd dimensions and angles.

## TOOLS NEEDED

- 🌿 Broom

## ACTIONS

- 🌿 Remove all equipment, debris and pallets from the roof.
- 🌿 Use left-over growing media and plants to fill in bare spots, if any.
- 🌿 Sweep the vegetation-free zone if you have installed pavers.
- 🌿 Make sure that nobody comes to work on the roof after installation. The vegetation will die off if it is walked on too often.

Total Installation

1 full truck



3 h



4 persons



*Sweeping the vegetation-free zones*

After the plants have been installed, do not allow any construction traffic on the roof. If post-installation construction activity is unavoidable, please consult us before the contractor starts.



## TOOLS NEEDED

- Irrigation supply: hose, tripod sprinklers
- Irrigation timer

Watering 1 roof

 40 min

 2 persons

## ACTIONS

- Position hoses and overhead sprinklers so that they provide optimum coverage of the vegetated area of the roof.
- Program the irrigation for 30 minutes.
- Check the HYDROPACK® reservoirs in different places to make sure they are full of water, if they are not, water for a little longer. To check the water level in the reservoirs, lift the filter cloth in the tray.
- For the first year, the vegetation will need to adapt to its new environment. We recommend that you water during the summer (July-August), once a week for 30 minutes.
- After the first year, water during periods of drought: > 90 °F (32 °C) with less than 0.6” rainfall (15 mm) for 20 consecutive days.

If you're planning to install a permanent irrigation system, we can design and provide the equipment necessary.



*Watering after installation – this small sprinkler must be repositioned to ensure that the entire roof receives the correct amount of water.*



*Permanent overhead irrigation*



*Dry water reservoir*



*Low water reservoir*



*Full water reservoir*

**THE VEGETATION MUST BE CHECKED REGULARLY, AT LEAST ON A WEEKLY BASIS TO ENSURE THAT THE PLANTS ARE ADAPTING WELL. AFTER ONE MONTH, THE PLANTS CAN BE CHECKED QUATERLY.**

**IF YOU NOTICE A PROBLEM CALL VEGETAL I.D. RIGHT AWAY.**



*HYDROPACK® Green Roof System Shenandoah University in Winchester, VA*

## HYDROPACK® MAINTENANCE GUIDE

**H**YDROPACK® can be purchased with a limited plant warranty. To qualify for this warranty, the building owner and or its agents has to contract a maintenance program following the requirements of this maintenance guide. The building owner or its agents, including but not limited to the installer, the maintenance contractor will have to follow precisely this maintenance guide and provide to Vegetal i.D. photographs and reports when visiting the green roof, following vegetal i.D.'s requirements.

HYDROPACK® needs little maintenance; however, maintenance is very important, and the success of your green roof will depend on it.

### TOOLS NEEDED

- 🌱 Bucket
- 🌱 Knife, gloves, small shovel
- 🌱 Hand spreader (we recommend the 3100 Professional Hand Crank Spreader from Earthway)
- 🌱 Slow release fertilizer – organic or inorganic.
- 🌱 Irrigation supply



### ACTIONS

- 🌱 The first visits should occur weekly during the first month after the installation to verify that the vegetation is properly establishing. Watering might be necessary during this period.
- 🌱 Minimum maintenance for a **Standard Plant Mix** is 4 times per year. For other plant mix, ask our team.
- 🌱 During extended periods of drought plants may suffer. At such times, install a temporary irrigation system. Irrigation is required for any period of 20 days or more with less than 0.6" of cumulative rainfall and temperatures above 90°F. Under these conditions water for 30 minutes once a week until the weather improves.

ACTIONS	JAN	FEB	MAR	APR	MAY	JUN	JUL	AUG	SEP	OCT	NOV	DEC
Weeding				■		■		■		■		
Plant health				■		■		■		■		
Watering						■	■	■				
Repair				■						■		
Fertilizing				■								
Drain inspection				■						■		
Garbage removal				■		■		■		■		

**HYDROPACK® is very easy to maintain because it is delivered to the roof with the vegetation already fully established.**

## DETAILED MAINTENANCE PROGRAM

Valid for zones 3-8. Outside these zones contact the [Vegetal I.D. team](#) for advice.

### ACTIONS

#### WEEDING

Weed before the plants go to seed (for most weeds this means mid-spring to summer, depending on weather conditions). You can walk on the vegetation, but gently and not often. Pull out the weeds from the base. Pull out the entire root and put them in a plastic bag to prevent the seeds from spreading.

Fill in any bare patches with sedum cuttings from surrounding trays.

Remember that watering your green roof will increase weed pressure. If you water your roof frequently, you'll need to weed more often (once a month). Too much irrigation will promote high weed pressure, so manage your irrigation with care.

Don't use any chemical weed control products without first consulting [Vegetal I.D.](#)

#### PLANT HEALTH INSPECTION

For each visit, answer the following questions:

- 🌱 How many different types of plants do you see?
- 🌱 How many different types of weeds?
- 🌱 What is the estimated plant cover?
- 🌱 Do you see any insects or wildlife?

#### PHOTOS REQUIREMENTS

- 🌱 identify each photo with the quote number initially provided
- 🌱 each photo must depict a digital original date reflecting when the date that the photograph was taken
- 🌱 for each visit, take a minimum of 6 photos, 3 general views and 3 close up.



*Weeds that you may find on your green roof*



*Bare spot*

*Scrape off the growing media*



*Place cuttings*

*Cover with growing media*





## HYDROPACK® MAINTENANCE

Valid for zones 3-8. Outside these zones contact the [Vegetal I.D. team](#) for advice.

### ACTIONS

#### FERTILIZING

To ensure prolific blooming on a highly visible roof, apply fertilizer each spring; otherwise, every 2 years, in the spring.

Use a hand spreader (the 3100 Professional Hand Crank Spreader from Earhtway), and be sure to wear a mask, gloves and eye protection.

Follow the fertilizer manufacturer's instructions. We usually recommend a slow (18-month) fertilizer (18,6,12), but it really depends on the needs of the plants and the climate conditions. Please consult us for a detailed fertilization program. Water for 30 minutes after each application.

You'll begin to see the effect on the plants after about three weeks.

#### WATERING

With the exception of limited circumstances, we do not recommend the installation of a permanent irrigation system (pitched roof, some regions, etc... ).

Watering is important after installation and throughout the first summer. A temporary irrigation system is sufficient, using tripod stand sprinklers.

In long periods of drought you should water the roof until the water reservoirs are full. It usually takes about 30 minutes with a water pressure of 35 psi. The definition of a long period of drought is 20 consecutive days with less than 0.6" of cumulative rainfall and temperatures above 90°F. Under these specified conditions, water for 30 minutes once a week.

If you have bare spots on your roof, water them every week until the plants grow back.

For irrigation supplies and advice please contact [Vegetal I.D.](#)

If you plan to install permanent irrigation, contact [Vegetal I.D.](#) for approval of the layout and the system itself. We provide lay out, ready-to-install kits that include weather stations, controller, connections, sprinklers and pipes.



#### CLEANING THE DRAINS

Remove roots, vegetation, and any signs of moss appearing in the roof drains.

#### REMOVE TRASH AND LEAVES

Pick up any leaves and trash that have fallen onto the vegetation.

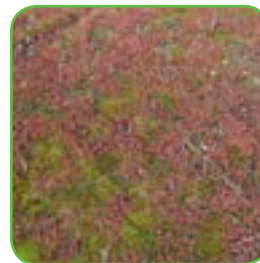

Lack of Fertilization



Fertilization equipment



Leaves covering the plants



Irrigation electro valves



Sprinkler



Weather station

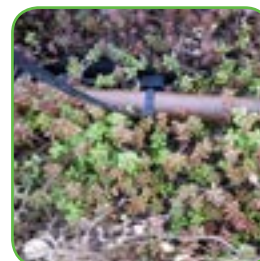

Drip Irrigation attachment



Automated valves

# MAINTENANCE FIELD NOTES

QUOTE NUMBER \_\_\_\_\_

DATE OF INSTALLATION \_\_\_\_\_

DATE	NAME	COMPANY	ADDRESS	PHONE/EMAIL

MAINTENANCE	CHECK	OBSERVATION
Plant health inspection		
Weeding		
Vegetation replacement		
Fertilization (type, rate)		
Drain inspection and cleaning		
Garbage removal		
Watering		
Plant coverage (Percent)		
Number of plant varieties		
Number and name of different weeds		
Insect or wildlife		

## COMMENTS:



## CHECK LIST FOR THE BUILDING OWNER AND ITS AGENTS

ACTIONS	CHECK	DATE
Read the Installation and Maintenance Guide		
Contact the waterproofing membrane rep. to know the warranty requirements if any (TSW)		
Verify that all work has been done on the roof		
Test the waterproofing membrane for leaks		
Schedule the Green Roof Shipment		
Print a copy of the Installation Guide to have with you during the installation		
Call 585-343-6400 if you have any question on the process		
If you cannot install all the trays the same day, call our team for further instructions on how to store the plants		
Lock the trays together and verify at the end of the installation that no space remains between them		
Take photos during and after the installation and during the irrigation when a limited plant warranty is pursued (minimum 6, 3 overall and 3 close up).		
Water the entire Green Roof for 30 minutes minimum		
Send the pictures to our team the following day		
Check the vegetation weekly for the first month, watering if necessary		
Visit the green roof quaterly, providing reports and photos to Vegetal i.D.		

## CONTRACTOR'S CERTIFICATION

**Fax this page to Vegetal i.D. before the shipment date: 585-343-6401**

I \_\_\_\_\_, manager/installer of the products provided by Vegetal i.D. Inc. on (date) \_\_\_\_\_, for (project's name) \_\_\_\_\_ located at (project's address) \_\_\_\_\_, acknowledge, agree with, and certify to the following:

1. I have read, and agree with the terms of installation and maintenance, attached hereto as Guide and Instructions to Installation and maintenance.
2. I agree to contact and notify Vegetal i.D. Inc. within 24 hours of the delivery of Hydropack, of any problems, or issues that may impact installation, or anything related thereto.
3. I understand that if I do not contact and notify Vegetal i.D. Inc. within 24 hours of the delivery of the plants or Hydropack, of any problems, or issues that may impact installation, or anything related thereto, that Vegetal i.D. Inc. will deem the products as accepted.
4. I understand and agree to the following before installation begins:
  - i. That all required preparations including the following have been completed: confirmation that the roof is ready for installation of the product (please refer to the checklist in the Guide and Instructions to Installation for the roof being ready), examination of product for defect, completion of the proper approvals including but not limited to architect's and other professionals' of suitability of the site for the application of the product, proper water proofing, and testing of the same.
  - ii. Coordinate delivery, and installation to ensure healthy viable plants, and proper installation.
5. I agree to install the product, following the step by step instructions as set forth in the Guide and Instructions to Installation and maintenance.
6. I agree to contact and notify Vegetal i.D. Inc. of any issues or potential problems that may arise during installation, and not to proceed further, without appropriate instructions from Vegetal i.D. Inc..
7. I agree to notify Vegetal i.D. Inc. of the completion of the project, within 24 hours of such completion.

I certify to all of the foregoing,

Name:

Title:

Date:

Phone:



## Vegetal i.D. Inc.

Tel: 585-343-6400

Fax: 585-343-6401

Email: [sales@vegetalid.com](mailto:sales@vegetalid.com)

Address: 7939 Bank St. Rd.  
Batavia, NY 14020, USA

[www.vegetalid.us](http://www.vegetalid.us)